



Originate from TTWEN

**LiFePO4**

**12.8V100Ah**

(100A BMS)

# PRODUCT MANUAL

Lithium Iron Phosphate(LiFePO4) Battery



[info@ttwen.com](mailto:info@ttwen.com)



<http://ttwen.com>



# NOTE!



## Battery series parallel prompts:

1. The batteries max number of series and parallel is 4S4P.
2. Before the battery is used in series or parallel, please make sure each battery capacity is 100%, the voltage difference is controlled within 0.2V, and the SOC is controlled within 5%.
3. When battery is used in series, the max current of charging and discharging is 100A.
4. When battery is used in parallel, the max current of charging and discharging is 200A.

# Contents

1. Things to Know Before Using .....	6
2. Scope .....	7
3. Battery-Pack Main Parameters .....	7
4. Battery Configuration .....	8
5. Battery Performance Criteria .....	9
5.1 Appearance .....	9
5.2 Measurement Apparatus .....	9
5.3 Standard Test Condition .....	9
5.4 Charging Methods .....	10
5.4.1 The Voltage When Charging & Discharging .....	10
5.4.2 Battery Charging Logic .....	11
5.4.3 LiFePO4 Battery Charging Mode .....	11
5.4.4 Solar Panel .....	11
5.4.5 Controller .....	12
5.4.6 Controller Settings .....	12
5.4.7 Battery Charger .....	12
5.4.8 Alternator/Generator .....	13
5.5 How to Estimate the Battery Capacity .....	13
5.5.1 State of Charge(SOC) .....	13
5.6 Series/Parallel Connection .....	14
5.6.1 The Premise of Connection .....	14
5.6.2 Limitation for Series/Parallel Connection .....	14
5.6.3 How to Connect Batteries .....	14
5.6.4 Accessory Recommendation .....	15
5.6.5 Step 1 Wear Insulating Gloves .....	16
5.6.6 Step 2 Voltage Balancing Before Connection .....	16
5.6.7 Step 3 Battery-to-Battery Connection .....	17
5.6.8 Step 4 Rebalancing Every 6 Months .....	19
5.6.9 Wiring Diagrams .....	19



# Contents

5.7 Inverter Settings .....	21
5.8 What to do When the Battery Stops Working? .....	22
5.9 Common Performance .....	24
5.10 Safety Performance .....	25
5.11 Rest Period .....	26
6. Storage and Others .....	27
6.1 Long Time Storage .....	27
6.2 Others .....	27
7. Protection Circuit .....	27
8. Appendix .....	29
9. App Download Clarification .....	31

# Product Specification

## Pack Battery



Length	Width	Height
332mm±2mm	176mm±2mm	221mm±2mm

## Terminal & Post Bolts

**Terminal Size: M8** (1.25mm Metric Thread)

**Post Bolts: M8** (1.25mm Metric Thread\*14mm Bolt Length)

(The bolts can be replaced with M8 bolts of other lengths based on actual needs.)

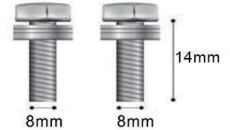

## Cell

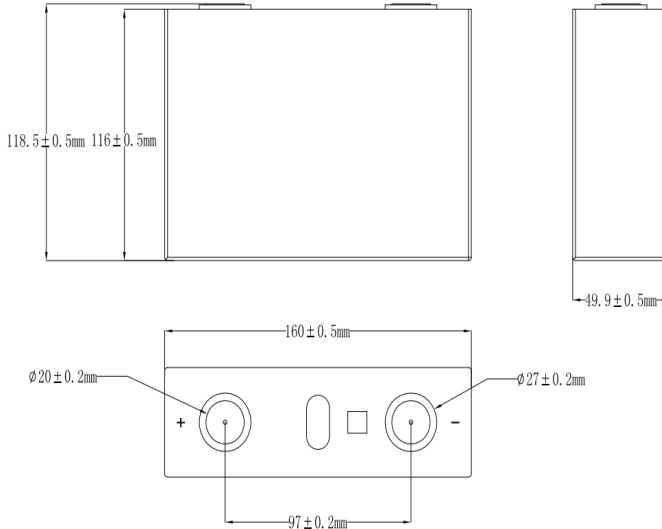

Length	Width	Height
118.5mm±0.5mm	160mm±0.5mm	49.9mm±0.5mm

# Product Specification

---

## Notice Before Using

**Step 1:** **CONTACT US** at [info@ttwen.com](mailto:info@ttwen.com) to activate the FIVE-YEARS WARRANTY

**Step 2:** **PULL OUT** Insulating Plugs.

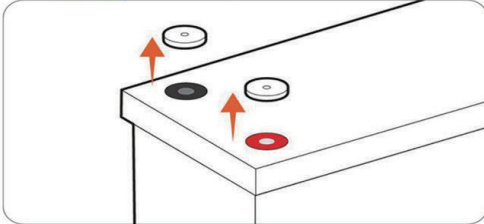

**Step 3:** **TIGHTLY SCREW IN** Post Bolts.

⚠ Please tightly screw in the post bolts. Having loose battery terminals will cause the terminals to build up heat resulting in damage to the battery.

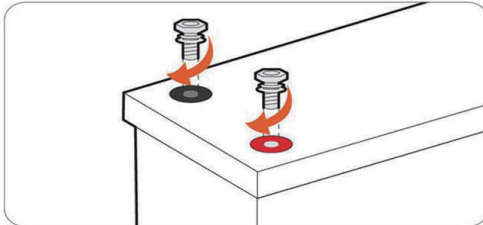

**Step 4:** **PUT OUT** Insulating Covers.

Please put on the insulating covers to avoid metal or conductive objects touching the positive and negative terminals of the battery at the same time, otherwise it is likely to cause a short circuit.

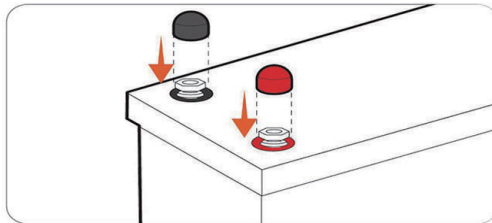

# Product Specification

---

**Step 5:** TEST The Battery Voltage with Multimeter.

≥12V To Step6

<12V Contact us at [info@ttwen.com](mailto:info@ttwen.com) to help solve the problem.

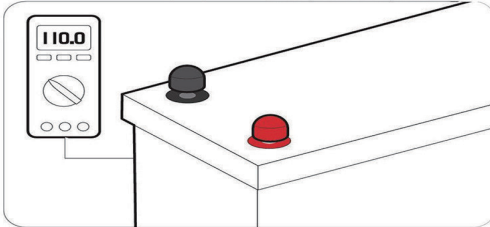

**Step 6:** FULLY CHARGE The Battery Separately.

(Refer to Page 10 for battery charging methods)

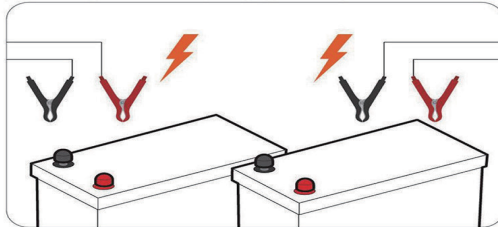

**Step 7:** CONNECT To Use.



# Product Specification

## 1. Things to Know Before Using

1. Always **put on the insulating covers** on the post bolts to avoid metal or conductive objects touching the positive and negative terminals of the battery at the same time, otherwise it is likely to cause a short circuit.
2. **Install the battery upright with post bolt facing up**, and it could not be mounted upside down.
3. **Tightly screw in the post bolts**. Having loose battery terminals will cause the terminals to build up heat resulting in damage to the battery.
4. This battery is not intended to be used to start any devices, please **DO NOT use it as a starting battery**.
5. Suggestions for **Long-term Storage**:

### (1) Temperature

The battery can be operated at a temperature of  $-20^{\circ}\text{C}$  to  $60^{\circ}\text{C}$  /  $-4^{\circ}\text{F}$  to  $140^{\circ}\text{F}$ , and a temperature between  $10^{\circ}\text{C}$  to  $35^{\circ}\text{C}$  /  $50^{\circ}\text{F}$  to  $95^{\circ}\text{F}$  is ideal for long-term storage. Store in a fireproof container and away from children.

### (2) Capacity

For a longer-lasting product, it is best to store your battery **at a 50% charge level** and recharge every three months if it is not going to be used for a long time.

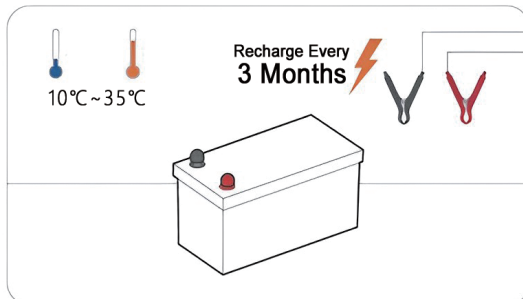

# Product Specification

## 2. Scope

The specification shall be applied to Li-ion rechargeable battery pack Of 12.8V 100Ah which is manufactured by TTWEN

## 3. Battery-Pack Main Parameters

NO	Items	Criteria	Remarks
3.1	Energy	1280Wh	0.2C charge discharge for voltage
3.2	Nominal Capacity	100Ah	
3.3	Usable Capacity	100Ah	
3.4	Nominal Voltage (V)	12.8V	
3.5	Combination Method	4S1P	
3.6	Charge Method	CC/CV	
3.7	Charge Voltage (V)	14.4V±0.2V	
3.8	Internal Impedance	Battery: ≤15mΩ	AC 1KHz after standard charge
3.9	Recommend Charge Current	20A(0.2C)	
3.10	Battery Management System (BMS) Board	100A	
3.11	Max. Continuous Charge Current	100A	Not recommended for long-term use
3.12	Max. Continuous Discharge Current	100A	
3.13	Max. Discharge Current 5 Seconds	280A	
3.14	Max. Continuous Load Power	1280W	
3.15	Pulse current	110A(3s)	
3.16	Cycle Life	≥4000 times	

# Product Specification

## 3. Battery-Pack Main Parameters

NO	Items	Criteria	Remarks
3.17	Battery Pack Case	Acrylonitrile Butadiene Styrene (ABS) Plastic	
3.18	Shipping Voltage Requirements	≥12.8V	
3.19	Protection Class	IP65	
3.20	Weight	10kg/22.05lb	
3.21	Dimension	L13.07*W6.93*H8.7 inch	
		L332*W176*H221 mm	
3.22	Temperature Range	Normal-Charge: 0 C to 50 C/32°F to 122°F	
		Normal-Discharge: -20 C to 60 C/-4°F to 140°F	
		Self-Heating Charge: -20 C~50 C/-4°F-122°F	
		Self-Heating Discharge: -20 C-60 C/4°F-140°F	
		Storage: -10 C to 50 C/14°F to 122°F	

## 4. Battery Configuration

NO	Items	Criteria	Remarks
4.1	Gotion-manufactured Cell	IFP50160116-102Ah	LiFePO4
4.2	BMS	JBD-DP04S007	
4.3	Connector		

# Product Specification

---

## 5. Battery Performance Criteria

### 5.1 Appearance

There shall be no such defect as scratch, bur and other mechanical scratch, and the connector should be no rust dirt. The structure and dimensions see attached drawing of the battery. It's required that the battery must match well with the mobile phone of 12.8V100Ah.

### 5.2 Measurement Apparatus

#### (1) Dimension Measuring Instrument

The dimension measurement shall be implemented by instruments with equal or more precision scale of 0.01mm.

#### (2) Voltmeter

Standard class specified in the national standard or more sensitive class having inner impedance not less than 10 K $\Omega$ /V.

#### (3) Ammeter

Standard class specified in the national standard or more sensitive class. Total external resistance including ammeter and wire is less than 0.01 $\Omega$ .

#### (4) Impedance Meter

Impedance shall be measured by a sinusoidal alternating current method (AC 1kHz LCR meter).

### 5.3 Standard Test Condition

Test should be conducted with new batteries within one month after shipment from our factory and the cells shall not be cycled more than five times before the test. Unless otherwise defined, test and measurement shall be done under temperature of 23 $\pm$ 2 $^{\circ}$ C and relative humidity of less 75%., air 86Kpa~106Kpa.



# Product Specification

---

## 5.4 Charging Methods

Full charge condition: Constant current 0.1C, Constant voltage 14.6V for 16 hours in all at  $23\pm 2^{\circ}\text{C}$ .

### 5.4.1 The Voltage When Charging & Discharging

Based on the characteristics of Lithium Iron Phosphate ( $\text{LiFePO}_4$ ) batteries, the voltage measured by all  $\text{LiFePO}_4$  batteries during charging/discharging is not the real voltage of the battery. Therefore, after charging/discharging and disconnecting the battery from the power source, the voltage of the battery will gradually drop/increase to its real voltage.

If you need to test the real voltage of the battery, please disconnect all the connections to the battery and test its voltage after putting it aside for over 30 mins.

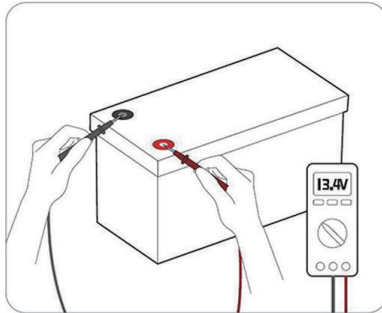

### Tips When Testing The Battery Voltage by A Multimeter

1. Put the red probe (+) **tightly** on the positive terminal (not the post bolts), and the black probe (-) on the negative terminal.
2. Do not touch the metal part of the probes with your hands during use.

# Product Specification

## 5.4.2 Battery Charging Logic

The material characteristics of the LiFePO<sub>4</sub> battery determine that its charging curve is obviously different from that of a lead-acid battery. Compared with a lead-acid battery, the LiFePO<sub>4</sub> battery has a simpler charging process and mode. Therefore, it is recommended to select LiFePO<sub>4</sub> for your charging mode. If LiFePO<sub>4</sub> mode is not available, please refer to the recommended parameters on Page 12 for setting.

## 5.4.3 LiFePO<sub>4</sub> Battery Charging Mode

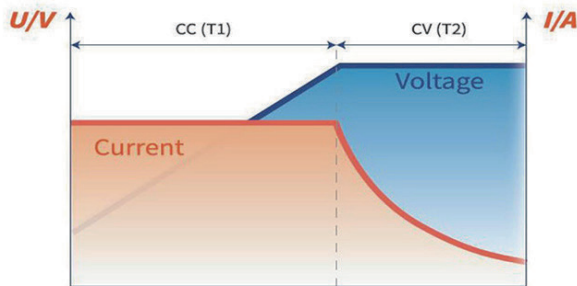

LiFePO<sub>4</sub> Battery Charging Curve

### 1. CC(Constant Current)Phase (T1)

In the beginning, a discharged battery will be charged with a constant current and voltage will be climbing steadily until reaching the constant voltage setpoint which varies for different charging methods.

### 2. CV(Constant Voltage)Phase (T2)

The battery maintains a constant voltage during this phase while the current gradually decreases to 2A (0.02C) which is also known as tail current. At this point, the charging is cut off and the battery is fully charged.

## 5.4.4 Solar Panel

1. Recommend Power:  $\geq 900W$
2. The battery can be fully charged in one day (with effective sunshine 4.5hrs/day) by 900W solar panels.
3. It may take more than one day to fully charge the battery by 900W solar panels since the duration and intensity of light would be a great factor for their charging efficiency.

# Product Specification

## 5.4.5 Controller

1. Recommend Charging Mode: 14.6V LiFePO4
2. Recommend Charging Current:

20A(0.2C)	The battery will be fully charged in around 5hrs to 100% capacity
50A(0.5C)	The battery will be fully charged in around 2hrs to around 97% capacity

## 5.4.6 Controller Settings

Refer to the below parameters if you need to manually set up your controller.

As different types of batteries have different charging modes (refer to Page 10), it is recommended to set only the following parameters for LiFePO4 batteries. The settings for other types of batteries do not apply to LiFePO4 batteries except for the following settings.

Charging	Charge/Bulk/Boost Voltage	14.4V/14.6V
	Absorption Voltage	14.4V/14.6V
	Over Voltage Disconnect	15V
	Over Voltage Reconnect	14.2V
	Tail Current	2A(0.02C)
Discharging	Under Voltage Warning	11.6V
	Under Voltage Recover	12V
	Low Voltage Disconnect	10.8V
	Low Voltage Reconnect	12.4V

## 5.4.7 Battery Charger

Use 14.6V lithium iron phosphate (LiFePO4) battery charger to maximize the capacity .

**1.Recommend Charging Voltage:** Between 14.2V to 14.6V

**2.Recommend Charging Current:**

20A(0.2C)	The battery will be fully charged in around 5hrs to 100% capacity
50A(0.5C)	The battery will be fully charged in around 2hrs to around 97% capacity

- Tips: ① Connect the charger to the battery before connecting it to the grid power in case of sparks.  
② It's recommended to disconnect the charger from the battery after fully charging.

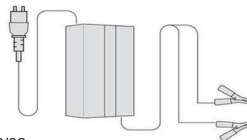

# Product Specification

---

## 5.4.8 Alternator/Generator

TTWEN battery can be charged by an alternator or generator. If the alternator/generator supports DC output, a DC-to-DC charger needs to be added between the battery and the generator; if the alternator/generator supports AC output, please refer to the recommendations in "Battery Charger" above to add a suitable battery charger between the battery and the generator.

**1.Recommend Charging Voltage:** Between 14.2V to 14.6V

**2.Recommend Charging Curent:**

20A(0.2C)	The battery will be fully charged in around 5hrs to 100% capacity
50A(0.5C)	The battery will be fully charged in around 2hrs to around 97% capacity

## 5.5 How to Estimate the Battery Capacity

### 5.5.1 State of Charge(SOC)

The battery capacity could be roughly estimated by its rest voltage (not charging/discharging voltage). As there are subtle differences in the voltage of each battery, the below parameters are for reference only.

Rest Voltage : The voltage needs to be tested at rest (with zero current after 30 mins of disconnectin from the char er & loads.

# Product Specification

## 5.6 Series/Parallel Connection

### 5.6.1 The Premise of Connection

To connect in series or/and parallel, batteries should meet the below conditions;

- Identical batteries with the same battery capacity (Ah) and BMS (A);
- From the same brand (as lithium battery from different brands has their special BMS);
- Purchased in near time (within one month).

### 5.6.2 Limitation for Series/Parallel Connection

Support connecting up to 16 identical batteries for up to 4 in series as 48V(51.2V) battery system/  
4 in parallel as 400Ah battery system.

**Series Connection**  
48V(51.2V)100Ah

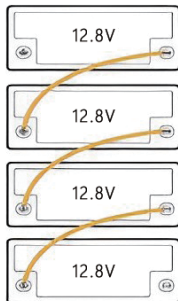

**Parallel Connection**  
12V(12.8V)400Ah

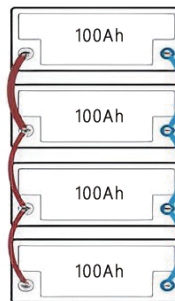

### 5.6.3 How to Connect Batteries

#### Battery series parallel prompts:

- The batteries max number of series and parallel is 4S4P.
- Before the battery is used in series or parallel, please make sure each battery capacity is 100%, the voltage difference is controlled within 0.2V, and the SOC is controlled within 5%.
- When battery is used in series, the max current of charging and discharging is 100A.
- When battery is used in parallel, the max current of charging and discharging is 200A.

# Product Specification

## 5.6.4 Accessory Recommendation

1. Battery-to-Battery Connection Cable: 2\*6AWG Copper Cable

2. Total Input & Output Connection: Adding two copper bars except for the cables.

**Step 1:** Refer to Page 17-19 to finish your battery-to-battery connection.

**Step 2:** Connect all the positive output cables of the batteries to one copper bar.

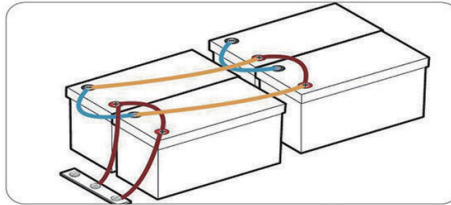

If the positive (+) of the battery is connected to the negative (-) of other batteries (i.e. in series connection), the + cannot be connected to the copper bar, otherwise the battery system will fail to connect in series.

**Step 3:** Connect the **+** of the load to the copper bar.

The cable gauge used in this step should be able to support the total input & output current of the entire battery system.

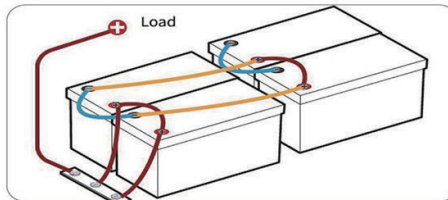

**Step 4:** The **-** of the battery system and load are also connected to another copper bar following the above steps.

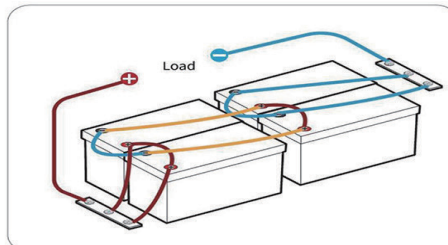

# Product Specification

## 5.6.5 Step 1 Wear Insulating Gloves

Wear Insulating Gloves for protection before connecting. Please pay attention to operation safety in the process of connection.

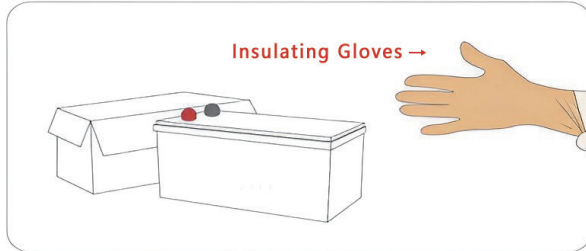

## 5.6.6 Step 2 Voltage Balancing Before Connection

Below two steps are necessary to reduce the voltage difference between batteries and let the battery system perform the best of it in series or/and in parallel.

1. Fully charge the batteries separately  
(voltage at rest: 13.4V)

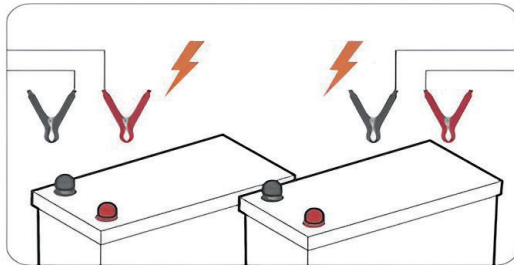

2. Connect the batteries one by one in parallel, and leave them together for 12~24 hrs.

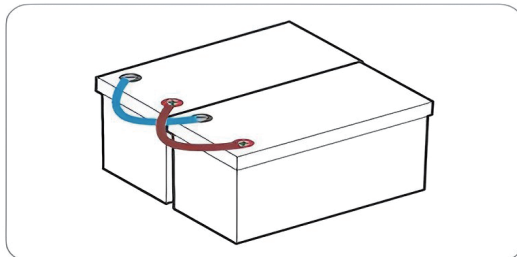

# Product Specification

3. They can then be connected in series or parallel.

(voltage at rest: 13.4V)

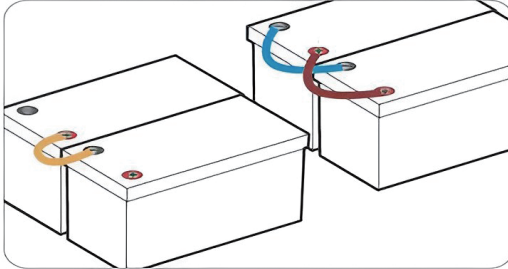

## 5.6.7 Step 3 Battery-to-Battery Connection

1. Connect Batteries in Series  $\oplus$  to  $\ominus$

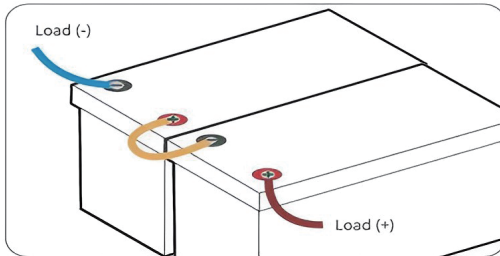

After series connection, the voltage of the battery system will be doubled according to the number of batteries you connect.

E.g. If two 12V 100Ah batteries are connected in series, the battery system will be 24V (25.6V) 100Ah.

2. Connect Batteries in Parallel  $\oplus$  to  $\oplus$   $\ominus$  to  $\ominus$

Refer to Page 14 for total input & output connection

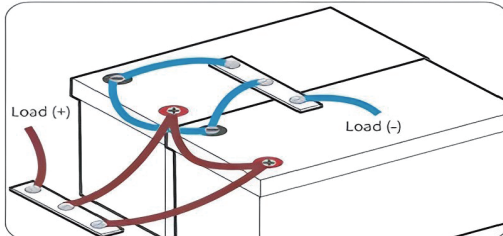

After parallel connection, the capacity of the battery system will be doubled according to the number of batteries you connect.



# Product Specification

E.g. If two 12V 100Ah batteries are connected in parallel, the battery system will be 12V (12.8V) 200Ah.

### 3. Connect Batteries Both in Series & Parallel Optimal Connection Method Recommendation

a. Connect the batteries in parallel

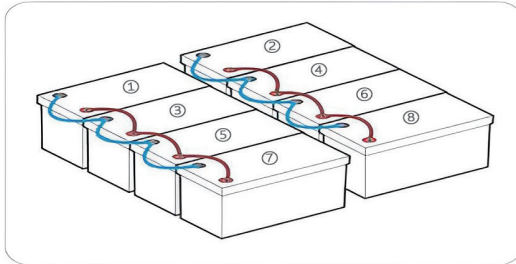

b. Connect the paralleled battery systems in **series**.

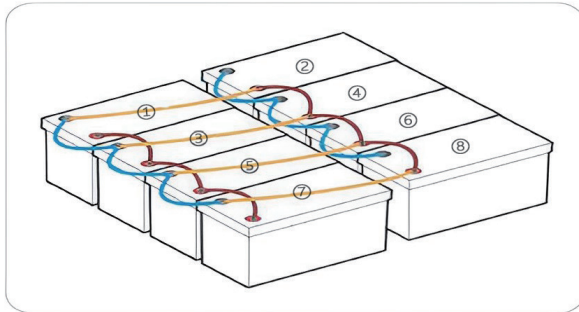

4. Connect the positive  $\oplus$  of battery ①/③/⑤/⑦ to a copper bar and the  $\oplus$  of the load to the same copper bar. And then connect the negative  $\ominus$  of ②/④/⑥/⑧ to another copper bar and the  $\ominus$  of the load to the same copper bar.

Refer to Page19 for 2S2P,2P4S battery system wiring diagram.

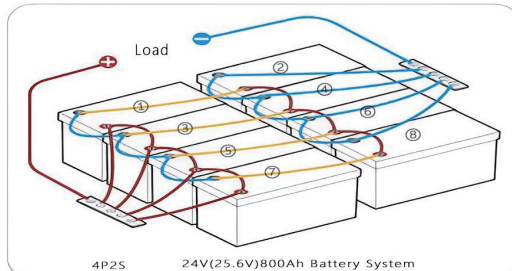

# Product Specification

As  $\ominus$  of ①/③/⑤/⑦ is connected in series with  $\oplus$  of ②/④/⑥/⑧, please do not connect  $\ominus$  of ①/③/⑤/⑦ with  $\ominus$  of load or  $\oplus$  of ②/④/⑥/⑧ with  $\oplus$  of load, otherwise the battery system will fail to connect in series.

## 5.6.8 Step 4 Rebalancing Every 6 Months

It is recommended to rebalance the battery voltage every six months following Step 2 on Page 16 if you're connecting multiple batteries as a battery system, as there might be voltage differences after six months of the battery system running.

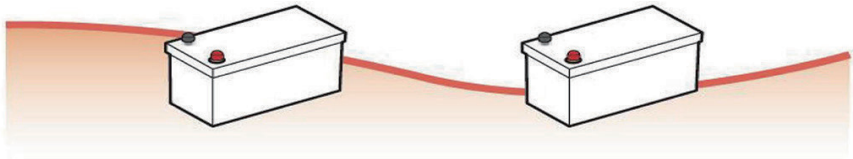

## 5.6.9 Wiring Diagrams

2S2P	Battery System	24V(25.6V)200Ah
	Energy	5120Wh
	Max. Continuous Charge / Discharge Current	200A
	Max.Continuous Load Power	5120W

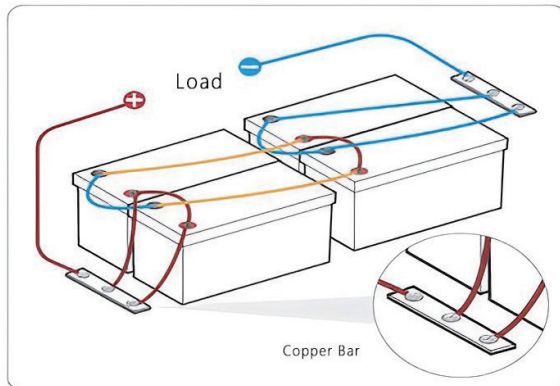

# Product Specification

2P4S	Battery System	48V(51.2V)200Ah
	Energy	10240Wh
	Max. Continuous Charge / Discharge Current	200A
	Max.Continuous Load Power	10240W

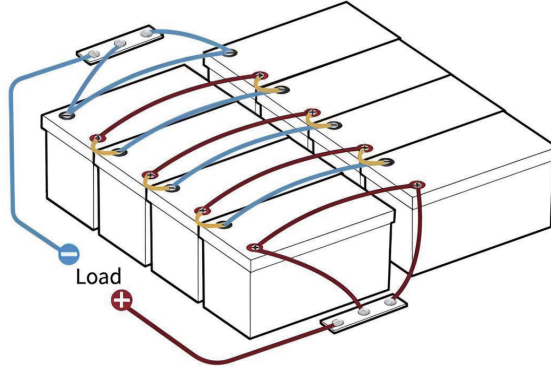

4P2S	Battery System	24V(25.6V)400Ah
	Energy	10240Wh
	Max. Continuous Charge / Discharge Current	400A
	Max.Continuous Load Power	10240Wh

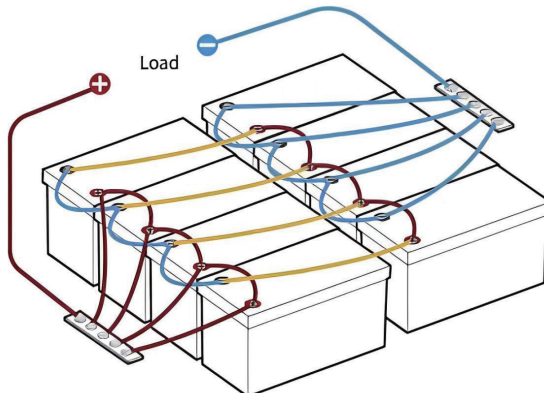

# Product Specification

---

## 5.7 Inverter Settings

### 1. Method One (Recommend)

Select "14.6V LiFePO4 Mode"

### 2. Method Two

If method one is not available, select "User Mode" to enter values according to below parameters.

Charging	Charging Voltage	14.6V
	Over Voltage Disconnect	15V
	Over Voltage Reconnect	14.2V
Discharging	Under Voltage Warning	11.6V
	Under Voltage Recover	12V
	Low Voltage Disconnect	10.8V
	Low Voltage Reconnect	12.4V

The above setting parameters apply to common inverters on the market (such as Victron, Renogy, Growatt, Xantrex, Go Power, Lux Power, etc). Different brands have slightly different descriptions or naming methods for each parameter. Please directly set the parameters with the same meaning.

If the inverter parameters to be set are special or cannot correspond to one of the above items, please contact [Info@ttwen.com](mailto:Info@ttwen.com) for confirmation.

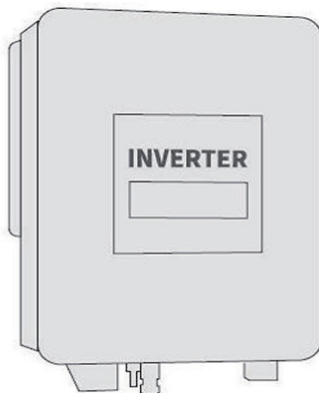

# Product Specification

## 5.8 What to do When the Battery Stops Working?

When the battery



or

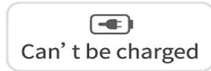

or



It has 85% chances that BMS has shut it off for protection, and you could try one of below ways to activate the battery.

### 1. General Steps

If the BMS has cut off the battery for protection, follow the below steps to activate it.

Step 1: **Cut off** all the connections from the battery.

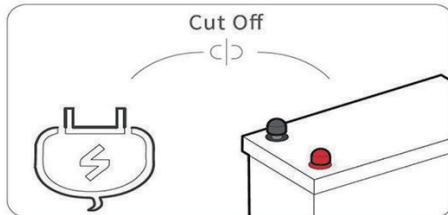

Step 2: **Leave the battery aside for 30mins**

Then the battery will automatically recover itself to normal voltage (>10V) and can be used after fully charged.

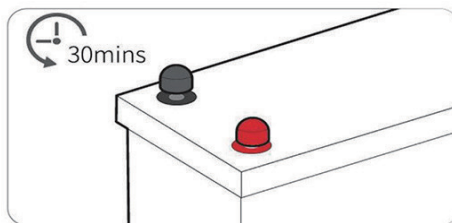

If the battery is unable to recover itself after the above steps, please try activating by **ONE OF BELOW TWO METHODS.**

After activated (voltage>10V) and fully charged by the normal charging method, it can be used normally.

# Product Specification

## 2. Method ①

Use a charger with a 0V charging function① to fully charge the battery.

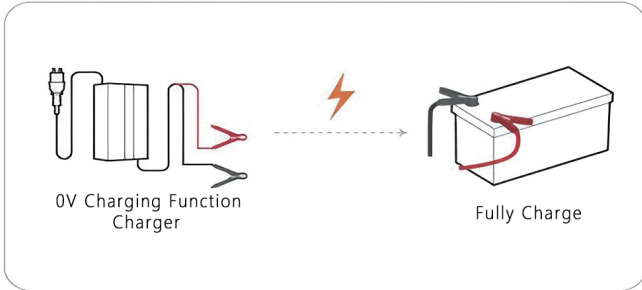

## 3. Method ②

Connect an 18V~36V solar panel to charge the battery for 3~10s in sunny daytime.

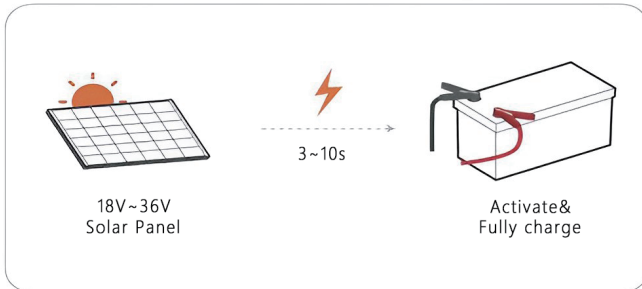

# Product Specification

## 5.9 Common Performance

NO	Items	Testing method and determinant standard
1	Charge Performance	The battery can be charged when using the original charger. The standard charge mode :under the temperature of $23\pm 2^{\circ}\text{C}$ ,charge the battery with the current of 0.1C until the voltage reaches up to 14.6V,then charge with constant voltage until the charge current $\leq 0.02\text{C}$ , then stop charging.
2	Discharge Performance	When connecting with load, the battery can supply power. Charge the battery with standard charge mode, then rest for 0.5h, then discharge with 0.1C until the voltage is 10V, and the discharge time is required $\geq 5\text{h}$ . The cycle life is required 5 times.
3	Cycle Performance	Under the temperature of $23\pm 2^{\circ}\text{C}$ ,charge the battery with 0.1C, when the voltage reaches up to 14.6V charge with constant voltage until the charge current $\leq 0.02\text{C}$ , then stop charging, then rest for 0.5h, then discharge with 0.1C to 10V. Cycle with the above mode, when the continuous discharge time $< 3\text{H}$ stop cycling. The cycle life is required $\geq 300$ times.
4	Charged Storage Characteristics	Charge the battery with 0.1C, then shift to charge with constant voltage until the voltage reaches up to 14.6V, when the charge current $\leq 0.02\text{C}$ stop charging;rest under the temperature of $23\pm 2^{\circ}\text{C}$ for 28d then discharge with 0.1C to 10V. The discharge time is required $\geq 4.25\text{h}$ .
5	Storage Characteristics	Charge the battery ,which is new manufactured shorter than 3 months, with 0.1C until the capacity reaches to 40~50%, after resting for 12 months under the temperature of $20\pm 5^{\circ}\text{C}$ and the humidity of 45~75%, then charge with 0.1C to 14.6V then shift to charge with constant voltage, under the temperature of $23\pm 2^{\circ}\text{C}$ , after full-charge rest for 0.5h,then discharge with 0.1C to 10V. The discharge time is required $\geq 4\text{h}$ . The cycle life is required 5 times.

# Product Specification

## 5.10 Safety Performance

NO	Items	Testing method and determinant standard
1	High Temperature Characteristics	Under the temperature of $23\pm 2^{\circ}\text{C}$ , after charging the battery with 0.1C, then put the battery into the constant temperature and humidity oven with $65\pm 2^{\circ}\text{C}$ for 2h, then discharge with 0.1C to 10V. The discharge time is required $\geq 4\text{H}$ and the battery should no deformation and smoking.
2	Low Temperature Characteristics	Under the temperature of $-20^{\circ}\text{C}$ , after charging the battery with 0.1C, then put the battery into the constant temperature and humidity oven with $-40\pm 2^{\circ}\text{C}$ for 4h, then discharge with 0.1C to 10V. The discharge time is required $\geq 0.1\text{h}$ and the battery should no deformation and smoking.
3	Overcharge Protection Characteristics	After full-charging the battery with 0.1C and set the constant current and voltage supplier with 2times of the nominal voltage and current, then load it to the battery for 7h. It is required the battery should be no leakage, deformation, smoking and explosion during the test processes.
4	Over-discharge Protection Characteristics	Under the temperature of $23\pm 2^{\circ}\text{C}$ , after discharging the battery with 0.1C to 10V, then connect the load with $n \times 30\Omega$ then discharge for 7h. It is required the battery should be no leakage, in fire, smoking and explosion during the test processes.
5	Short-circuit Protection Characteristics	Under the temperature of $23\pm 2^{\circ}\text{C}$ , after full-charging the battery with 0.1C, then make the battery's anode and cathode short-circuit for 1h (the connecting resistance is smaller than $80\pm 20\text{m}\Omega$ ), and there should be no leakage, deformation, smoking and explosion during the test processes.



# Product Specification

---

NO	Items	Testing method and determinant standard
6	Constant Humidity and Temperature Characteristics	Under the temperature of $23\pm 2^{\circ}\text{C}$ , after charging the battery with 0.1C, then put the battery into the constant temperature and humidity oven with $40\pm 2^{\circ}\text{C}$ and 90 ~ 95% for 48h, the battery should be no obvious deformation, leakage, rust, smoking and explosion. After testing take out the battery then rest for 2h under the temperature of $23\pm 2^{\circ}\text{C}$ , discharge with 0.1C to 10V. The discharge time is required $\geq 3\text{H}$ .
7	Drop Test	After charging the battery, put it aside for 1H ~ 4H for testing. 1. Drop the battery onto the concrete with a free fall height of 1m. Drop one on each side of the battery Times, a total of six tests. After the test, measure the voltage and visually inspect the appearance of the battery. 2. Drop the battery pack onto the concrete with a free fall height of 1.5m. Each side of the battery falls Once, a total of six tests were conducted. After the test, measure the voltage and visually inspect the battery appearance. There should be no leakage, fire or explosion.

## 5.11 Rest Period

Unless otherwise defined, 30min, rest period after charge, 30min, rest period after discharge.

# Product Specification

## 6. Storage and Others

### 6.1 Long Time Storage

If stored for a long time(exceed three months), the cell should be stored in drying and cooling place. The cell's storage voltage should be 12.9~13.1V and the cell is to be stored in a condition that the temperature of  $23\pm 2^{\circ}\text{C}$  and the humidity Of 45%- 75%.

### 6.2 Others

Any matters that this specification does not cover should be conferred between the customer and TTWEN.

## 7. Protection Circuit

Item	Content	Criterion
Voltage	Charging voltage	DC:14.6V CC/CV
	Balance voltage for single cell	$3.45\pm 0.025\text{V}$
Current	Balance current for single cell	$36\pm 10\text{mA}$
	Current consumption	$\leq 70\mu\text{A}$
	Recommend charge current	$\leq 50\text{A}$
	Max continues discharge current	$\leq 100\text{A}$
	Pulse current(time)	110A (3S)
Over Charge Protection	Over charge detection voltage	$3.65\pm 0.025\text{V}$
	Over charge detection delay time	0.5~2.0S
	Over charge release voltage	$3.50\pm 0.05\text{V}$

# Product Specification

Item	Content	Criterion
Over Discharge Protection	Over discharge detection voltage	2.50±0.05V
	Over discharge detection delay time	/
	Over discharge release voltage	2.80±0.10V
Over Current Protection	Over discharge current detection	110± 5 A
	Detection delay time 1	0.5~2.0S
	Detection delay time 2	50~150mS
	Over charge current detection current	/
	Detection delay time	0.5~2.0S
Short Protection	Short Circuit Protection Current	1050-1650A
	Detection delay time	200~800uS
	Detection condition	Exterior short circuit
	Release condition	Cut load, Auto Recovery
Temperature	Detect the temperature of the Mosfet	90 ±3°C
	Charging high temperature protection	60±5°C
	Charging low temperature protection	0±5°C
	Discharge high temperature protection	70±5°C
	Discharge low temperature protection	/
	Temperature protection release condition	Drop to 50°C, charge
	Operating temperature range	-20~+60°C
	Storage temperature range	0~45°C
Internal Resistance	Main loop electrify resistance	≤2mΩ

# Product Specification

---

## 8. Appendix

### Handling Precautions and Guideline For Li-ion Rechargeable Batteries

#### Preface

This document of 'Handling Precautions and Guideline Li-ion Rechargeable Batteries' shall be applied to the battery cells manufactured by TTWEN.

#### Note 1:

The customer is requested to contact TTWEN in advance, if and when the customer needs other applications or operating conditions than those described in this document. Additional experimentation may be required to verify performance and safety under such conditions.

#### Note 2:

TTWEN will take no responsibility for any accident when the cell is used under other conditions than those described in this Document.

#### Note 3:

TTWEN will inform, in a written form, the customer of improvement(s) regarding proper use and handling of the cell, if it is deemed necessary.

### Caution!

Do not use or store the battery where is exposed to extremely hot, such as under window of a car in direct sunlight in a hot day. Otherwise, the battery may be overheated. This can also reduce battery performance and/or shorten service life.

If the battery leaks and electrolyte gets in your eyes, do not rub them. Instead, rinse them with clean running water and immediately seek medical attention. If left as is, electrolyte can cause eye injury.

# Product Specification

---

## Danger!

- Do not immerse the battery in water or allow it to get wet.
- Do not use or store the battery near sources of heat such as a fire or heater.
- Do not use any chargers other than those recommended by TTWEN.
- Do not reverse the positive(+) and negative(-) terminals.
- Do not connect the battery directly to wall outlets or car cigarette-lighter sockets.
- Do not put the battery into a fire or apply direct heat to it.
- Do not short-circuit the battery by connecting wires or other metal objects to the positive(+) and negative(-) terminals.
- Do not pierce the battery casing with a nail or other sharp object, break it open with a hammer, or step on it.
- Do not strike, throw or subject the battery to sever physical shock.
- Do not directly solder the battery terminals.
- Do not attempt to disassemble or modify the battery in any way.
- Do not place the battery in a microwave oven or pressurized container.
- Do not use the battery in combination with primary batteries(such as dry-cell batteries) or batteries of different capacity, type or brand.
- Do not use the battery if it gives off an odor, generates heat, becomes discolored or deformed, or appears abnormal in any way. If the battery is in use or being recharged, remove it from the device or charger immediately and discontin-ue use.

## 9. Bluetooth APP download instructions

### Step 1

Scan the QR code below to download the APP supports Android and Apple systems

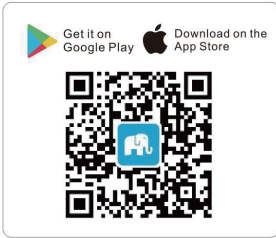

### Step 2

Choose to open in the browser and follow the prompts to download the corresponding operating system APP



### Step 3

Open and enter the APP registration or login account

Email account

---

Password

---

[SIGN IN](#)

[JUMP LOGIN](#)

[Quick registration](#)   [Forgot password?](#)

### Step 4

After successful login, the APP will automatically jump to the < Device list >interface, and select the device you want to connect (such as TN 0001 according to Bluetooth coding)



Click to connect

# APP Interface Usage Instructions

SOC display diagram, charging switch, discharge switch, equilibrium status, multiple temperature parameters, protection status, and other real-time data display, as shown in the schematic diagram below.

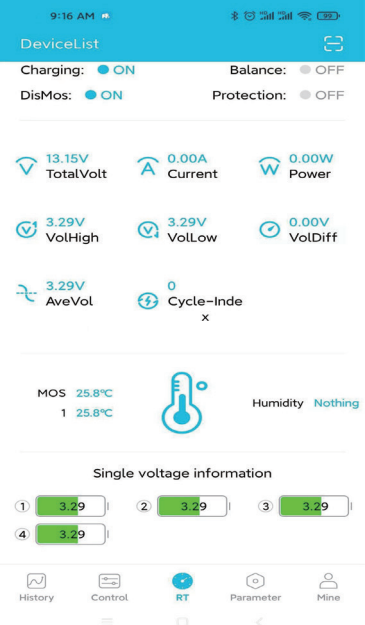
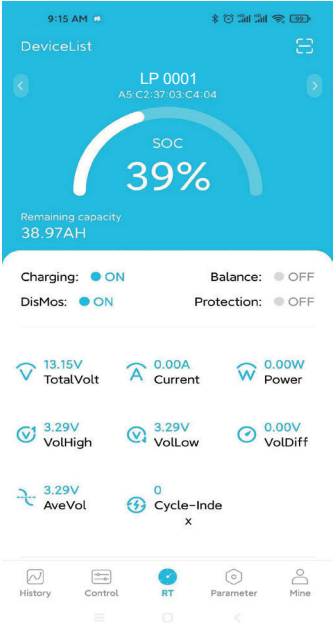



Originate from TTWEN



[info@ttwen.com](mailto:info@ttwen.com)



<http://ttwen.com>